



Lauko durys

RD80/RD100



Lauko durys viena iš svarbiausių namo fasado detalių. Jas matome ir naudojame kiekvieną dieną, todėl jos turi būti saugios, šiltos ir sandarios, derančios su namo fasadu ir nereikalaujančos nuolatinės priežiūros. Siūlome platų, individualiai gaminamų lauko durų, asortimentą. Durų gamyboje naudojamos šiuolaikinėmis technologijomis, kuriame išskirtinį dizainą ir ilgaamžiškumą.

Siūlome platų pasirinkimą standartinių ir individualių matmenų, taip pat galimybę susikurti durų dizainą patiems.

Ryterna Entry yra viena iš Ryterna group įmonių gaminančių vartus ir duris Europoje nuo 1993 metų. Turėdami savo filialus visoje Europoje ir krovininio transporto parką galime užtikrinti trumpiausią įmanomą tiekimo terminą. Tapdami draugiškesni gamtai, laikomės tvarumo ir žiedinės ekonomikos principų, todėl mūsų klientai gali būti tikri, kad gaus kokybiškus ir draugiškus aplinkai gaminius.

www.ryterna.lt
www.ryternaentry.doorconfigurator.com



Modeliai	4
Savybės	70
Stiklas	74
Spalvos	75
Šoniniai ir viršutiniai langai	76
Rankenos	78
Priedai	80
Rakinimo sistemos	82
Standartiniai modeliai	84
Išskirtiniai modeliai	92





Tipas **318**
Modelis **RD100**
Išorės spalva **RAL9002**
Rankena **H90S-1200**
Cilindro apdaila **ESC-1**
Stiklas **Matinis SGM**
Apdaila **Raižiniai**

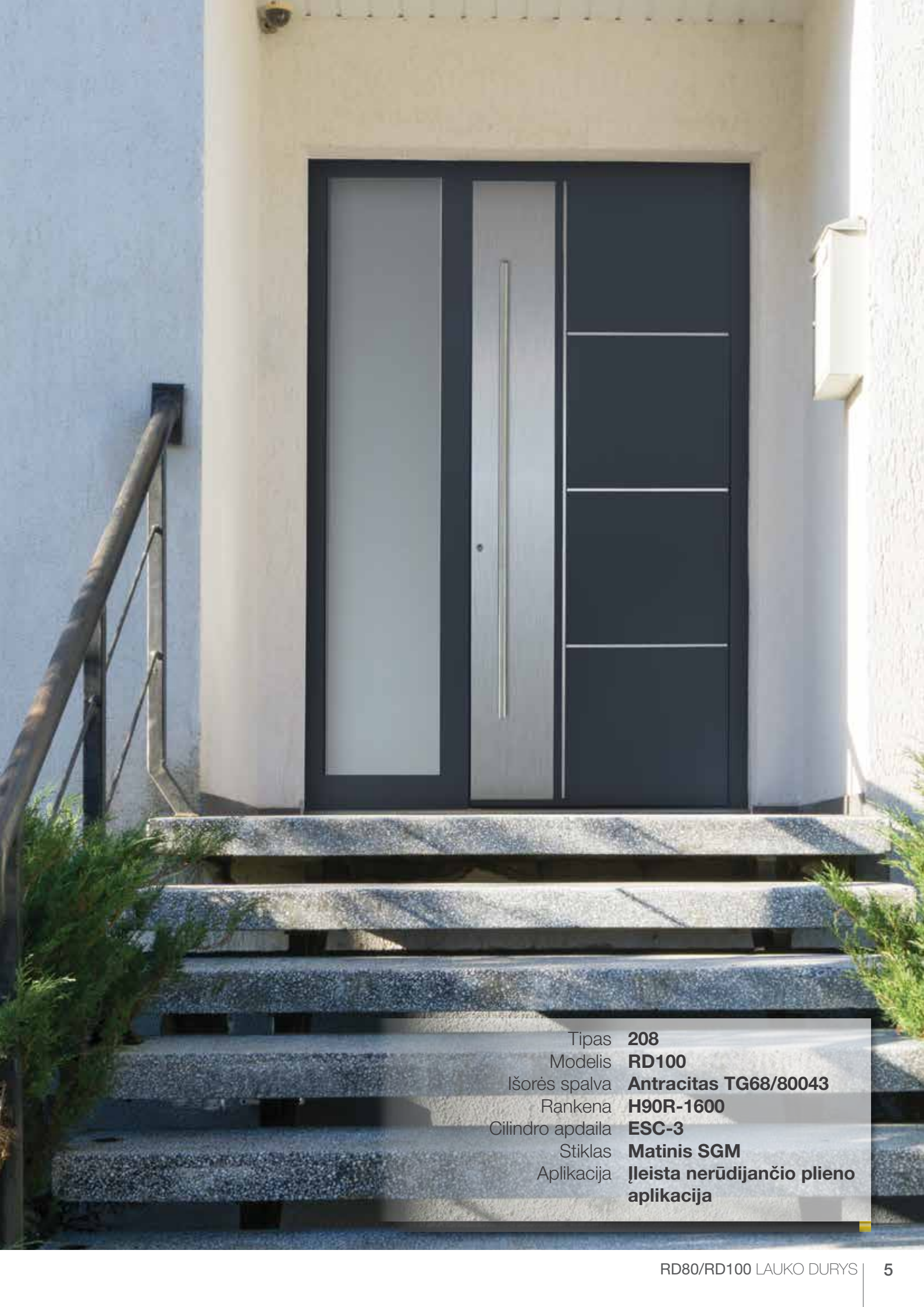

Tipas	208
Modelis	RD100
Išorės spalva	Antracitas TG68/80043
Rankena	H90R-1600
Cilindro apdaila	ESC-3
Stiklas	Matinis SGM
Aplikacija	Įleista nerūdijančio plieno aplikacija



Tipas **207**
Modelis **RD100**
Išorės spalva **RAL7016**
Rankena **H90R-1200**
Cilindro apdaila **ESC-3**
Stiklas **Skaidrus**
Aplikacija **Įleista dažyta nerūdijančio
plieno aplikacija**



Tipas **200***
Modelis **RD80**
Išorės spalva **RAL7016**
Rankena **H90S-1600**
Cilindro apdaila **ESC-3**
Stiklas **Graviruotas**
*Individualus



Tipas **207**
Modelis **RD100**
Išorės spalva **RAL7016**
Rankena **H90S-1200**
Cilindro apdaila **ESC-3**
Stiklas **Graviruotas**
Aplikacija **Įleista nerūdijančio plieno aplikacija**
Apsauginė juosta **Lygi**



Tipas **602**
Modelis **RD80**
Išorės spalva **RAL7038**
Rankena **H90R-1200**
Cilindro apdaila **ESC-4**
Apdaila **Raižiniai**
Stiklas **Tonuotas SGT**
Aplikacija **Įleista „šukuoto“ nerūdijančio
plieno aplikacija**



Tipas **200***
Modelis **RD100**
Išorės spalva **RAL7016**
Rankena **H90R-1400**
Cilindro apdaila **ESC-3**
Stiklas **Matinis SGM**
Aplikacija **Įleista nerūdijančio plieno aplikacija**

*Individualus



Suderinti modeliai



Tipas **402**
Modelis **RD100**
Išorės spalva **RAL7016 / RAL3011**
Rankena **H90R-1200**
Cilindro apdaila **ESC-3**
Stiklas **Matinis SGM**
Aplikacija **Įleista „šukuoto“ nerūdijančio plieno aplikacija / dažyta**



Tipas **205**
Modelis **RD80**
Išorės spalva **RAL5015**
Rankena **H90S-1200**
Cilindro apdaila **ESC-2**
Aplikacija **Įleista nerūdijančio plieno aplikacija**



Tipas **304***
Modelis **RD100**
Išorės spalva **RAL5014/RAL9016**
Rankena **H45R-1200**
Cilindro apdaila **ESC-3**
Apdaila **Raižiniai**
*Individualus



Tipas **305***
Modelis **RD80**
Išorės spalva **RAL7002**
Rankena **H45R-500**
Cilindro apdaila **ESC-3**
Aplikacija **Įleista nerūdijančio plieno aplikacija**
*Individualus



Tipas **502**
Modelis **RD100**
Išorės spalva **RAL7031**
Rankena **HLS04**
Stiklas **Tonuotas SGT**



Tipas **508**
Modelis **RD80**
Išorės spalva **RAL7016**
Rankena **H90R-800**
Cilindro apdaila **ESC-3**
Stiklas **Matinis SGM**



Tipas **706**
Modelis **RD100**
Išorės spalva **RAL7016**
Rankena **H90S40B-800**
Cilindro apdaila **ESC-3**
Stiklas **Graviruotas**
Aplikacija **Įleista nerūdijančio plieno aplikacija**



Tipas **607**
Modelis **RD80**
Išorės spalva **RAL7016**
Rankena **H90R-800**
Cilindro apdaila **ESC-3**
Stiklas **Matinis SGM**
Aplikacija **Įleista nerūdijančio plieno aplikacija**



Tipas **639**
Modelis **RD80**
Išorės spalva **Antracitas TG68/80043**
Rankena **H90S40-800**
Cilindro apdaila **ESC-1**
Stiklas **Matinis SGM**
Aplikacija **Įleista „šukuoto“ nerūdijančio
plieno aplikacija**



Tipas **601**
Modelis **RD100**
Išorės spalva **RAL7006**
Rankena **H90R-1200**
Cilindro apdaila **ESC-3**
Stiklas **Graviruotas**
Aplikacija **Įleista nerūdijančio plieno aplikacija**



Suderinti modeliai



Tipas **635**
Modelis **RD80**
Išorės spalva **RAL7016**
Rankena **H45R-500**
Cilindro apdaila **ESC-3**
Stiklas **Matinis SGM**
Aplikacija **Įleista „šukuoto“ nerūdijančio
plieno aplikacija**



Tipas **701**
Modelis **RD80**
Išorės spalva **RAL9016**
Rankena **H45R-800**
Cilindro apdaila **ESC-3**
Stiklas **Matinis SGM**
Aplikacija **Įleista nerūdijančio plieno aplikacija**
Apdaila **Raižiniai**



Tipas **603**
Modelis **RD80**
Išorės spalva **RAL9016**
Rankena **H45R-500**
Cilindro apdaila **ESC-1**
Stiklas **Matinis SGM**
Aplikacija **Įleista nerūdijančio plieno aplikacija**



Tipas **630**
Modelis **RD80**
Išorės spalva **RAL-9016**
Rankena **H90R-1200**
Cilindro apdaila **ESC-3**
Stiklas **Skaidrus**
Aplikacija **Įleista nerūdijančio plieno aplikacija**



Tipas **603***
Modelis **RD80**
Išorės spalva **RAL7016**
Rankena **H90R-1200**
Cilindro apdaila **ESC-2**
Stiklas **Matinis SGM**
Aplikacija **Įleista nerūdijančio plieno aplikacija**
Apdaila **Raižiniai**
*Individualus



Tipas **639**
Modelis **RD80**
Išorės spalva **RAL1024**
Rankena **H90S-800**
Cilindro apdaila **ESC-1**
Stiklas **Matinis SGM**
Aplikacija **Įleista „šukuoto“ nerūdijančio
plieno aplikacija**



Suderinti modeliai



Tipas **207**
Modelis **RD80**
Išorės spalva **Old Oak**
Rankena **H90S-1800**
Cilindro apdaila **ESC-3**
Aplikacija **Įleista nerūdijančio plieno aplikacija**
Apsauginė juosta **Lygi**



Tipas **635***
Modelis **RD80**
Išorės spalva **Auksinis ąžuolas**
Rankena **H90S-1800**
Cilindro apdaila **ESC-3**
Stiklas **Skaidrus**
*Individualus



Tipas **650**
Modelis **RD80**
Išorės spalva **RAL7012**
Rankena **H45R-500**
Cilindro apdaila **ESC-3**
Finger scanner **FSC3**
Stiklas **Matinis SGM**
Apdaila **Raižiniai**



Tipas	651
Modelis	RD80
Išorės spalva	Antracitas TG68/80043
Rankena	H90R-1200
Cilindro apdaila	ESC-3
Stiklas	Matinis SGM
Aplikacija	Įleista nerūdijančio plieno aplikacija



Suderinti modeliai



Tipas **615**
Modelis **RD80**
Išorės spalva **Antracitas TG68/80043**
Rankena **H90S40-800**
Cilindro apdaila **ESC-3**
Stiklas **Matinis SGM**
Aplikacija **Įleista „šukuoto“ nerūdijančio
plieno aplikacija**



Tipas	902
Modelis	RD80
Išorės spalva	RAL9007/RAL9016
Rankena	H90SS40B 500mm
Cilindro apdaila	ESC-3
Stiklas	Matinis SGM
Aplikacija	Įleista nerūdijančio plieno aplikacija
Apdaila	Raižiniai



Tipas **655**
Modelis **RD80**
Išorės spalva **RAL9016**
Rankena **H90S-1800**
Finger scanner **FSC3**
Cilindro apdaila **ESC-3**
Aplikacija **Įleista nerūdijančio plieno aplikacija**
Stiklas **Matinis SGM**



Tipas **702**
Modelis **RD80**
Išorės spalva **RAL9007**
Rankena **H90S-1200**
Cilindro apdaila **ESC-3**
Stiklas **Graviruotas**
Aplikacija **Ileista nerūdijančio plieno aplikacija**
Apdaila **Raižiniai**



Tipas **652**
Modelis **RD80**
Išorės spalva **PP300/Juodas perlas**
Rankena **H90S-800+LED**
Cilindro apdaila **ESC-3**
Stiklas **Tonuotas SGT**
Aplikacija **Įleista nerūdijančio
plieno aplikacija**

Suderinti modeliai





Tipas **200***
Modelis **RD100**
Išorės spalva **RAL7040**
Rankena **HLS04**
Stiklas **Tonuotas SGT**
Aplikacija **Įleista nerūdijančio plieno aplikacija**
*Individualus



Tipas **704**
Modelis **RD100**
Išorės spalva **RAL9016**
Rankena **H90RB-1400**
Cilindro apdaila **ESC-3**
Stiklas **Graviruotas**
Aplikacija **Įleista nerūdijančio plieno
aplikacija**
Apdaila **Raižiniai**



Tipas **643***
Modelis **RD100**
Išorės spalva **RAL7016**
Rankena **HRB-800**
Cilindro apdaila **ESC-3**
Stiklas **Matinis SGM**
Aplikacija **Įleista nerūdijančio plieno aplikacija**
Apdaila **Raižiniai**
*Individualus



Tipas **703***
Modelis **RD100**
Išorės spalva **RAL9004/RAL9016**
Rankena **H90RB-1400**
Cilindro apdaila **ESC-3**
Stiklas **Graviruotas**
Aplikacija **Įleista nerūdijančio plieno aplikacija**
Apdaila **Raižiniai**
*Individualus



Tipas	Individualus
Modelis	RD80
Išorės spalva	Antracitas TG68/80043
Rankena	H90R-1600
Cilindro apdaila	ESC-1
Stiklas	Graviruotas
Aplikacija	Įleista nerūdijančio plieno aplikacija

Suderinti modeliai





Tipas **642**
Modelis **RD80**
Išorės spalva **Mars 2525 sable**
Rankena **H90R-1200**
Cilindro apdaila **ESC-3**
Stiklas **Tonuotas SGT**



Tipas	909
Modelis	RD80
Išorės spalva	RAL1007/RAL9016
Rankena	H90S-500
Cilindro apdaila	ESC-3
Stiklas	Graviruotas
Aplikacija	Įleista nerūdijančio plieno aplikacija
Apdaila	Raižiniai
Priedai	Anga laiškams
Apsauginė juosta	Lygi



Tipas **909**
Modelis **RD100**
Išorės spalva **RAL7016/RAL9016**
Rankena **H90RB-1400**
Cilindro apdaila **ESC-3**
Stiklas **Graviruotas**
Aplikacija **Ileista nerūdijančio plieno aplikacija**
Apsauginė juosta **Lygi**



Tipas **907**
Modelis **RD80**
Išorės spalva **RAL9016/RAL3032**
Rankena **H90R-1600**
Cilindro apdaila **ESC-2**
Stiklas **Tonuotas SGT**
Aplikacija **Įleista nerūdijančio plieno aplikacija**
Apdaila **Raižiniai**

Suderinti modeliai



Suderinti modeliai





Tipas **401***
Modelis **RD100**
Išorės spalva **RAL7016/RAL3032**
Rankena **H90S40B-800**
Cilindro apdaila **ESC-3**
Windows **Matinis SGM**
Aplikacija **Įleista nerūdijančio plieno aplikacija**
*Individualus



Tipas **1055***
Modelis **RD80**
Išorės spalva **Tiger 29/71335/Corten**
Rankena **IH-ALU/LED/Corten**
Finger scanner **FSC3**
Cilindro apdaila **ESC-3**
Stiklas **Matinis SGM**
*Individualus



Tipas **910***
Modelis **RD100**
Išorės spalva **Tiger 29/90147/Tiger 29/60740**
Rankena **HS-1000 / FSC3**
Cilindro apdaila **ESC-3**
Stiklas **Individualus graviravimas**
Aplikacija **Įleista nerūdijančio plieno**
aplikacija
Apdaila **LED**

*Individualus



Tipas **641**
Modelis **RD80**
Išorės spalva **Tiger 29/71335**
Rankena **H45R-1200**
Cilindro apdaila **ESC-3**
Stiklas **Matinis SGM**
Aplikacija **Įleistas auksinis ažuolas**



Tipas **804**
Modelis **RD80**
Išorės spalva **RAL7016 + Auksinis ažuolas**
Rankena **H90WD/G-1200**
Cilindro apdaila **ESC-3**
Stiklas **Graviruotas**
Aplikacija **Įleista nerūdijančio plieno aplikacija**
Apdaila **Raižiniai**



Tipas **705**
Modelis **RD100**
Išorės spalva **RAL7016**
Rankena **H90RB-800**
Cilindro apdaila **ESC-3**
Stiklas **Graviruotas**
Aplikacija **Įleista nerūdijančio plieno aplikacija+Senas ąžuolas**
Apdaila **Raižiniai**



Tipas	805
Modelis	RD80
Išorės spalva	RAL 9005 / Auksinis ažuolas
Rankena	H90WD/O-1200
Finger scanner	FSC3
Cilindro apdaila	ESC-3
Aplikacija	Įleista nerūdijančio plieno aplikacija
Stiklas	Graviruotas





Tipas **518***
Modelis **RD80**
Išorės spalva **Pušies plokštė**
Rankena **H90S-1600-FSC1**
Cilindro apdaila **ESC-2**
Stiklas **Skaidrus**
Apdaila **Raižiniai**
*Individualus



Tipas **1001**
Modelis **RD80**
Išorės spalva **RAL7016 + betono imitacijos apdaila**
Rankena **IH-ALU+LED+Betono imitacija-500**
Cilindro apdaila **ESC-3**
Aplikacija **Ileista nerūdijančio plieno aplikacija**







Tipas **1020**
Modelis **RD80**
Išorės spalva **RAL7016 / Corten imitacijos
apdaila**

Rankena **H90S40-1200**
Cilindro apdaila **ESC-3**

Aplikacija **Įleista nerūdijančio plieno aplikacija**



Tipas **1041**
Modelis **RD80**
Išorės spalva **RAL7016 / Medžio imitacijos apdaila**
Rankena **H90S40-1200**
Cilindro apdaila **ESC-3**
Stiklas **Graviruotas**



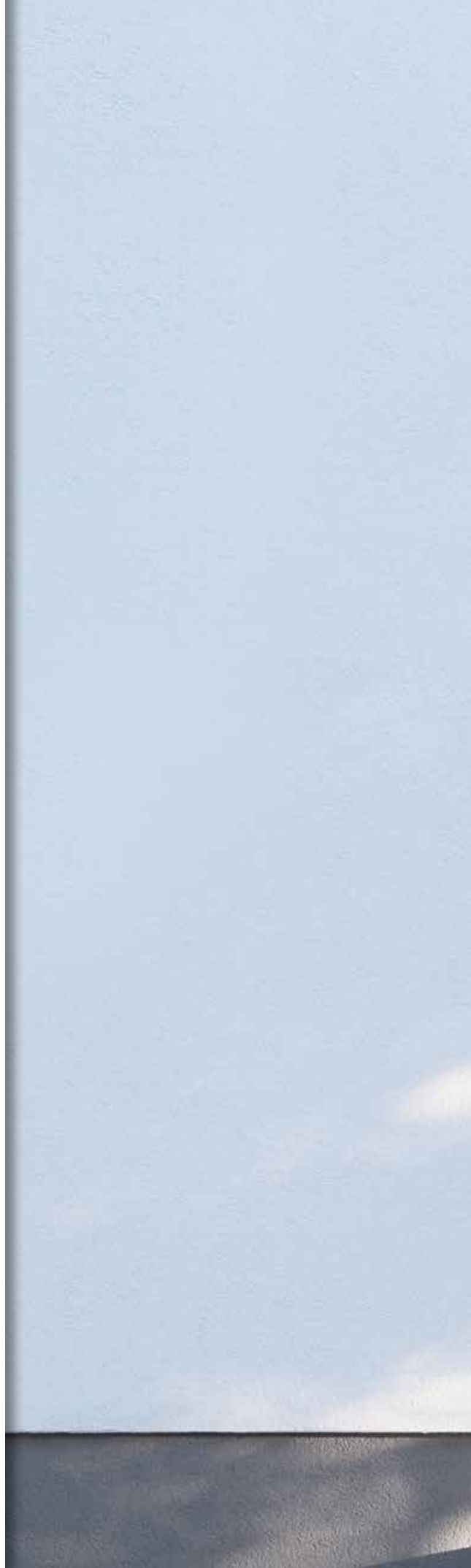



Tipas **1055**
Modelis **RD80**
Išorės spalva **TG68/80043 + Corten plieno imitacijos
apdaila + tamsintas stiklas**
Rankena **IH-ALU+LED+Corten-1800**
Cilindro apdaila **ESC-3**
Stiklas **Tonuotas SGT**

RD80

Durų stakta pagaminta iš aliuminio profilių su šalčio stabdžiu. Varčia sudaryta iš aliuminio profilių ir lakštų. Išorinis aliuminio lakštas 2.5 mm storio. Varčia užpildytas didelio tankio poliuretanu.

Visi langai varčioje su trigubo saugaus stiklo paketu.

Galimas dydis iki 1250mm plotis ir 2300mm aukštis. Dėl didesnių matmenų klauskite gamintojo.



Šiluminis laidumas
U vertė



0.69 W/m²K

Saugumo klasė
EN 12519



RC 3*

Atsparumas vėjui klasė
EN 12207:199-11



3

Atsparumo lietai klasė
EN 12208:199-11



6A

Laidumas garsui
EN 717-1:2013



32 Db

* RC2 standartas - RC3 papildomai

RD100

Slenkstis su magnetine “pop up” sandarinimo sistema. Atidarymas į lauką arba į vidų.

Langai duryse ir šoniniai elementai su trigubu gūdintu stiklu. Platus stiklo dekoravimo elementų pasirinkimas įskaitant individualų dizainą.

Galimas dydis iki 1250mm plotis ir 2300mm aukštis. Dėl didesnių matmenų klauskite gamintojo.

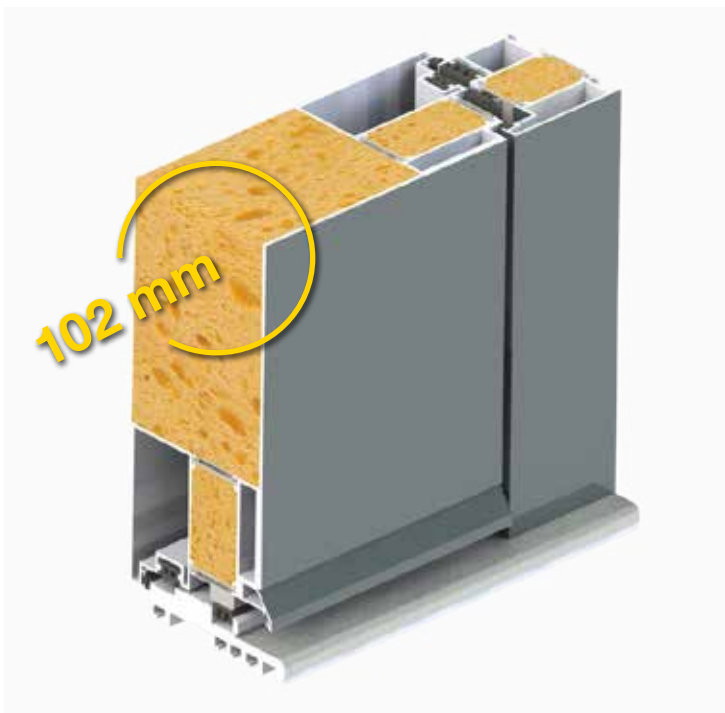

Šiluminis laidumas
U vertė



0.65 W/m²K

Saugumo klasė
EN 12519



RC 3*

Atsparumas vėjui klasė
EN 12207:199-11



3

Atsparumo lietai klasė
EN 12208:199-11



6A

Laidumas garsui
EN 717-1:2013



32 Db

* RC2 standartas - RC3 papildomai

Du staktos tipai

1. Lygi
2. Iškilii (tik durims atidaromoms į vidų)

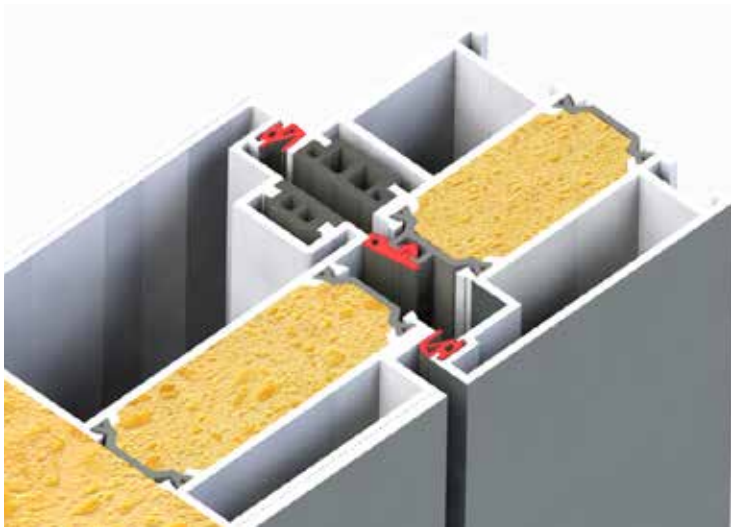

Varčia

Lygi - dengta aliuminio lakštais iš abiejų pusių. Triguba tarpinė (viena staktoje, 2 varčioje) užtikrina puikų sandarinimą.

Magnetinis slenkstis

Durų slenkstis turi trigubą sandarinimą su „pop-up“ magnetine sandarinimo sistema. Šiuolaikinės technologijos, tvirta ir nereikalaujanti priežiūros slenkščio sistema pagerina sandarinimą ir yra pritaikyta pravažiuoti vežimeliu. Uždarius duris, magnetinis sandarinimas pakyla ir puikiai uždengia tarpą tarp varčios ir slenkščio. Atidarius duris, magnetinis sandarinimas grįžta į griovelį slenkstyje.

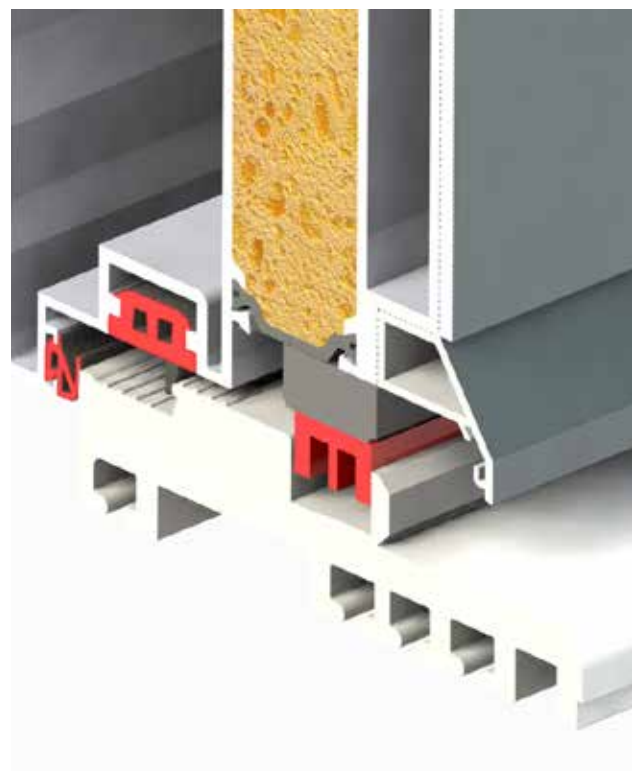

Lankstai

Priklausomai nuo staktos tipo, durys komplektuojamos su 3-mis lankstais, galinčiais išlaikyti iki 120kg svorio varčią. Lankstai tvirtinami savisriegiais varžtais į staktos pastiprinimo profilį taip išskaidant jį veikiančias jėgas ir nepažeidžiant tarpinių. Lankstai nesudėtingai reguliuojami trimis kryptimis.

Dr. Hahn
TÜRBÄNDER. MADE IN GERMANY.



Paslėpti lankstai

Wala WU sertifikuoti lankstai išlaiko varčią sveriančią iki 150kg, yra paprastai ir greitai surenkami, reguliuojami 3-mis kryptimis.

Paslėpti lankstai montuojami tik į RD100 duris.



WALA
www.wala.pl



P4A Saugus + 4mm Paprastas + P4A Saugus

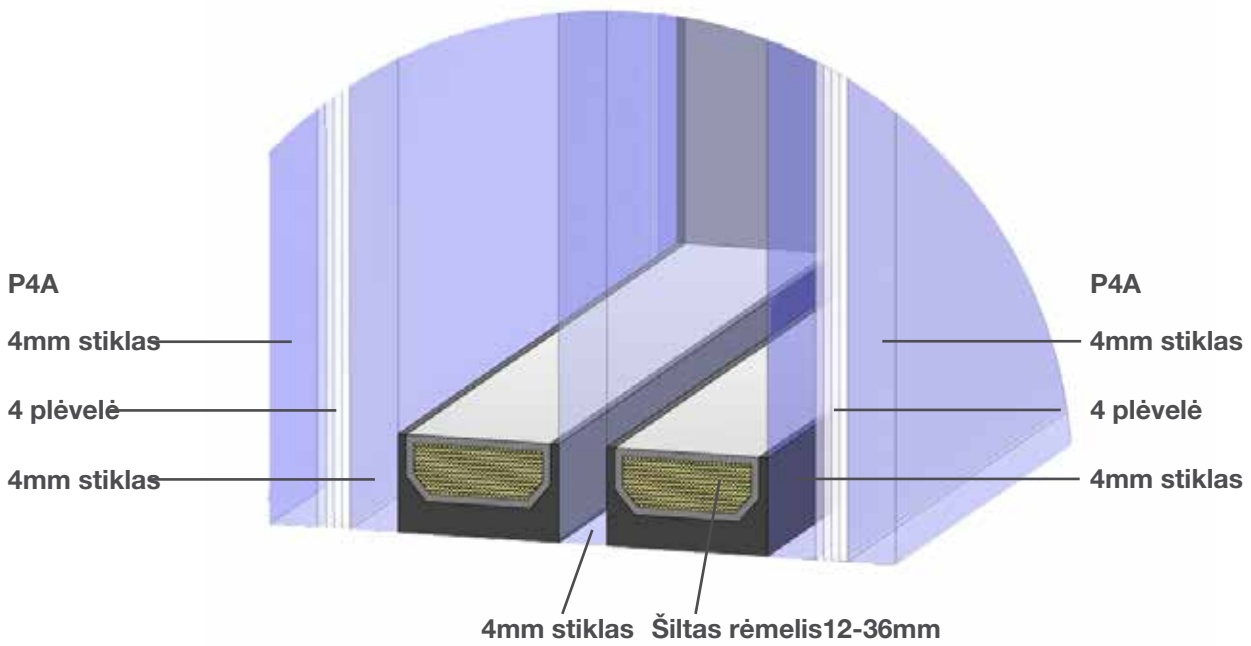

Standartinės RAL spalvos

Medžio imitacija

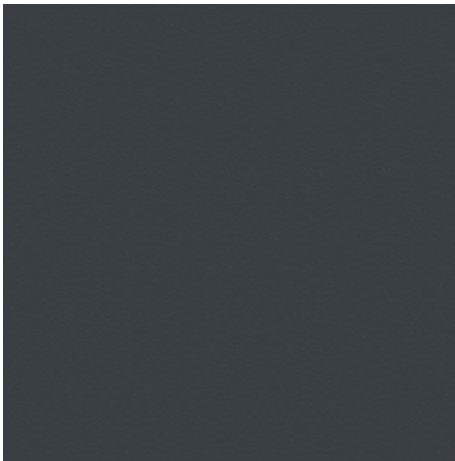

RAL 7016
Blizgus 20%

RAL 7016
Struktūra

Auksinis ąžuolas

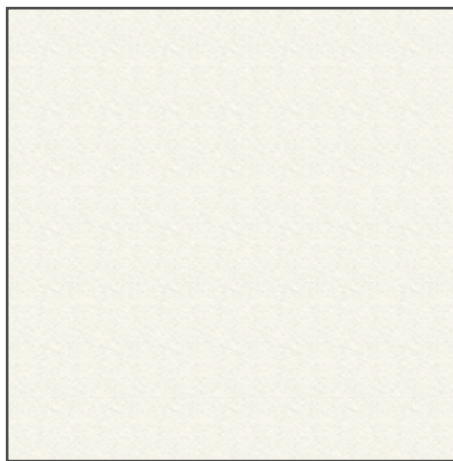

RAL 8017
Blizgus 20%

RAL 9016
Blizgus 20%

Senas ąžuolas

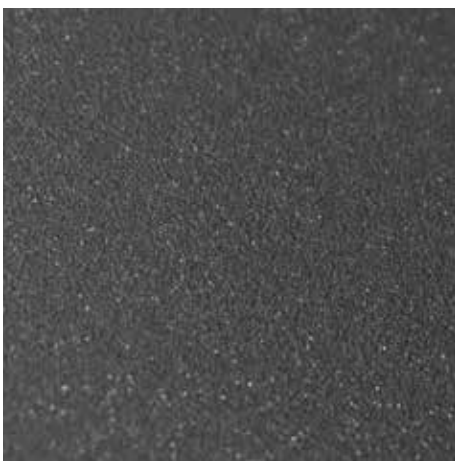

Kitos RAL spalvos



Struktūrinis dažymas užsakius individualiai

Antracitas
TG68/80043

*Spalvos buklete gali skirtis nuo realios, naudokite gamintojo pavyzdžius tiksliai spalvai nustatyti.

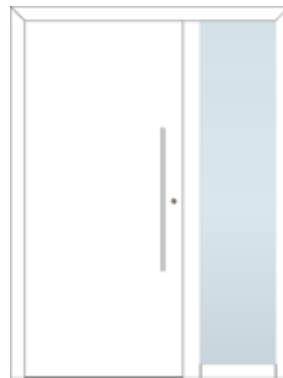
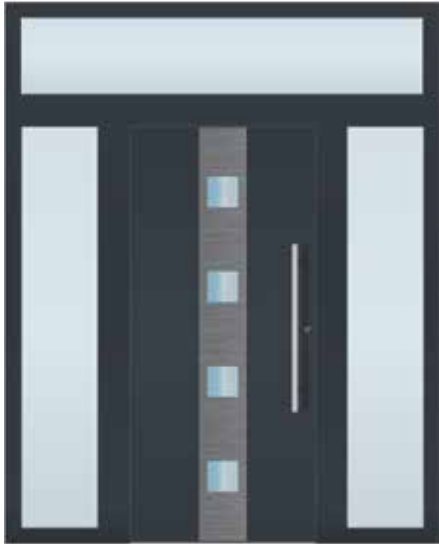

RW

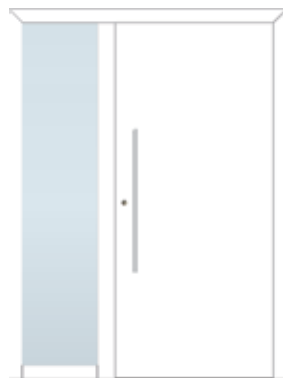

LW



LRW

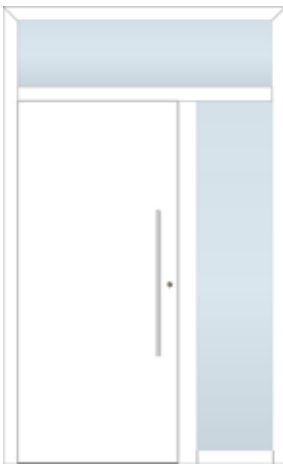

TRW

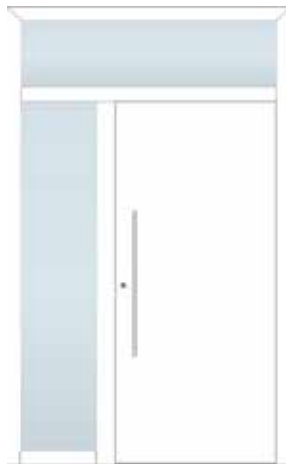

TLW

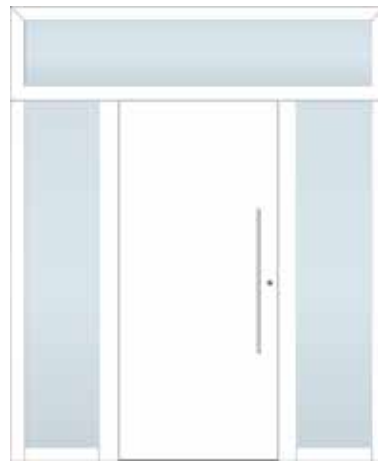

TLRW



TW

Stiklo graviravimas

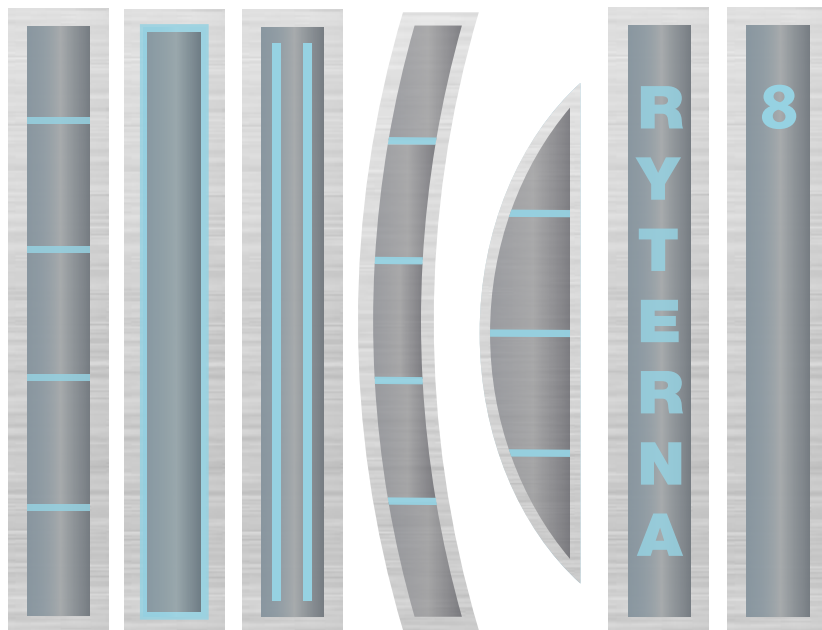

Įstiklinimo galimybės

Standartiniai



Skaidrus **SGC**



Matinis **SGM**



Raštuotas **SGP**

Nestandartiniai



Artimas Delta Nr. 121



Chinchilla



Katedral Klein



Artimas Silvit Nr. 118



Crepì



Tonuotas **SGT**

4mm Paprastas + 4mm Paprastas + 4mm Paprastas

P4A + 4mm Paprastas + P4A

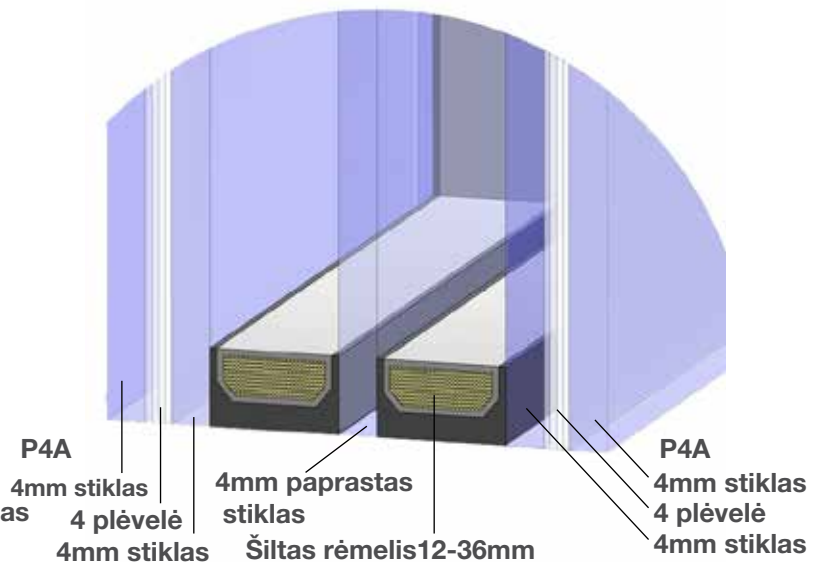
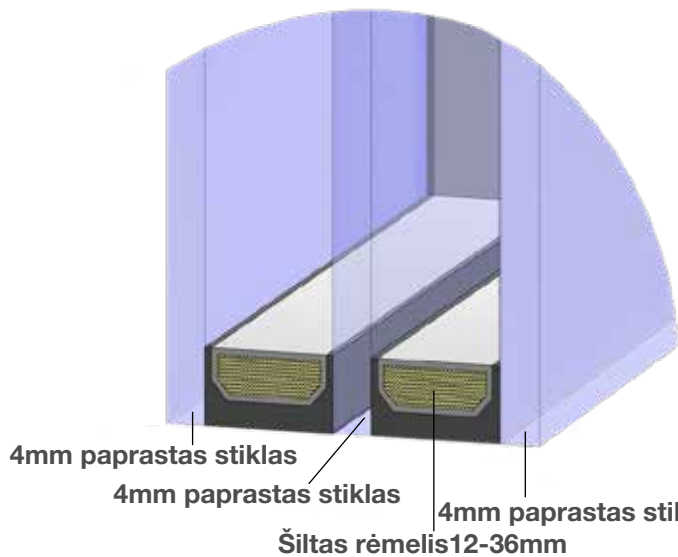

Nerūdijančio plieno rankenos

H45R

Ø 30 mm
45°
Galimas aukštis:
500 mm
800 mm
1200 mm
1400 mm
1600 mm

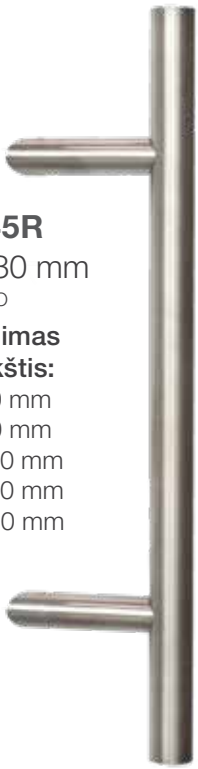

H45S

30x20 mm
45°
Galimas aukštis:
500 mm
800 mm
1200 mm
1400 mm
1600 mm

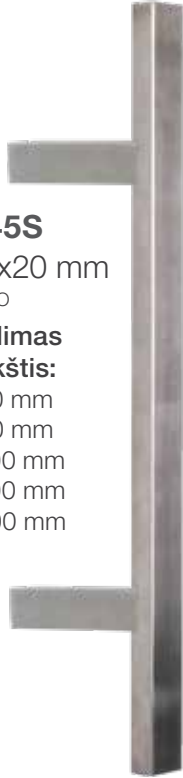

H90R

Ø 30 mm
90°
Galimas aukštis:
500 mm
800 mm
1200 mm
1400 mm
1600 mm
1800 mm



H90R+FSC1

Ø 30 mm
90°
Galimas aukštis:
500 mm
800 mm
1200 mm
1400 mm
1600 mm
1800 mm



H90S

30x20 mm
90°
Galimas aukštis:
500 mm
800 mm
1200 mm
1400 mm
1600 mm
1800 mm



H90S+FSC1

30x20 mm
90°
Galimas aukštis:
500 mm
800 mm
1200 mm
1400 mm
1600 mm
1800 mm



H90S40

40x10 mm
90°
Galimas aukštis:
500 mm
800 mm
1200 mm
1400 mm
2000 mm



H90S40B

40x10 mm
90°
Galimas aukštis:
500 mm
800 mm
1200 mm



H90RB

Ø 30 mm
90°
Galimas aukštis:
500 mm
800 mm
1200 mm
1400 mm
1600 mm



HRB

Ø 30 mm
Galimas aukštis:
500 mm
800 mm



HS

Galimas aukštis:
1000 mm



H90WD

Galimas aukštis:
800 mm
1200 mm
Galimos spalvos:
Auksinis ažuolas
Senas ažuolas



IH Galimas dydis:
(500x130 mm)



IH-ALU Galimi dydžiai
500 mm 1400 mm
800 mm 1600 mm
1200 mm 1800 mm

Nulenkiamos ir fiksuotos rankenos



HL-W (Balta)



HL-B (Juoda)



HK-W (Balta)*



HK-B (Juoda)*



HLA (Aliuminis)



HLS 01
(Nerūdijantis plienas)



HLS 02
(Nerūdijantis plienas)



HLS 03
(Nerūdijantis plienas)



HLS 04
(Nerūdijantis plienas)



HLS 05
(Nerūdijantis plienas)



HLS 06
(Nerūdijantis plienas)



HLS 07
(Nerūdijantis plienas)*



HLS 10 (Balta)



HLS 11 (Aliuminis)



HLS 12
(Nerūdijantis plienas)

*tik pora (abi pusės)

Cilindro apdaila

Galite rinktis iš penkių nerūdijančio plieno cilindro apdailų.



ESC-1



ESC-2



ESC-3



ESC-4



ESC-5
(su apsauga nuo pragrėžimo)



POL

Dalinio atidarymo užraktas

Baltas arba sidabro spalvos

Spynos cilindrai

WILKA cilindrai vertinami dėl saugumo ir ilgaamžiškumo. Rinkitės iš trijų saugumo klasių: A, B ir C (aukščiausia).

WILKA cilindrai komplektuojami su 5 raktais. Galimybė komplektuoti daugiau raktų.



CWA



CWA+TT



Pirštų antspaudų skaitytuvai

FSC1 - gali būti montuojamas varčioje arba rankenoje.

FSC2 - gali būti montuojamas varčioje arba sienoje naudojant nerūdijančio plieno priedus. Gali būti valdomas mobiliąja aplikacija, todėl duris galite atrakinti išmaniuoju telefonu.

FSC3 - saugus ir lengvai valdomas leidžia patogiai atrakinti duris. 4 kanalų siųstuvai suteikia galimybę vienu valdikliu atidaryti lauko duris, garažo ir kiemo vartus.

FSC4 - SIEGENIA pirštų antspaudų skaitytuvas naudoja SIBUS technologiją. Tiesioginis pajungimas be papildomo valdiklio. Integruotas valdymas WIFI ir Bluetooth. Iki 200 vartotojų. Galimybė valdyti SIEGENIA programėle.



FSC1



FSC2



FSC3



FSC4



Kodiniai valdikliai

KP1 - montuojamas ant sienos. Galimi 3 skirtingi kodai, 2 kanalų siųstuvas.

KP2/KP3 - kodinis valdiklis saugus ir lengvai valdomas. Gali būti montuojamas varčioje arba ant sienos.

KP4 - SIEGENIA kodinis valdiklis naudoja SI-BUS technologiją. Tiesioginis pajungimas be papildomo valdiklio. Integruotas valdymas WIFI ir Bluetooth. Iki 200 vartotojų. Galimybė valdyti SIEGENIA programėle.

KP5 - ENTRAcodē+ prieiga yra apsaugota skaitmeniniu kodu. Kodas gali būti 4-8 skaitmenų.



KP1



KP2



KP3



KP4



KP5

Spynos

KFV spynos pagamintos iš aukštos kokybės medžiagų. Naujausios technologijos užtikrina ilgaamžį, tikslų veikimą ir paprastą priežiūrą. Platus pasirinkimas nuo standartinių 3 taškų spynų iki kompleksinių 5 taškų spynų sprendimų.



L3P - 3 taškų spyna. Pagrindinis užraktas ir apsauginiai kaiščiai rakinami raktu.

L5P - 5 taškų spyna. Dvi skląstys užsirakina automatiškai uždarius duris ir yra atrakinamos raktu. Pagrindinis užraktas ir apsauginiai kaiščiai rakinami raktu.

L3P+D&N - 3 taškų spyna su galimybe atjungti automatinį užsirakinimą. Pagrindinis užraktas ir apsauginiai kaiščiai rakinami raktu.

L3P+D&N+EM electric - 3 taškų spyna su elektrine skląstimi ir galimybe atjungti automatinį užsirakinimą. Pagrindinis užraktas ir apsauginiai kaiščiai rakinami raktu.

L5PMA electric - 5 taškų spyna. Skląstis ir apsauginiai kaiščiai užsirakina automatiškai uždarius duris. Pagrindinis užraktas rakinamas tik raktu. Kai pagrindinis užraktas užrakintas raktu, automatinis atrakinimas atjungiamas, spyna gali būti sujungta su pirštų antspaudų skaitytuvu arba kodiniu valdikliu (papildomai)

L5PM be elektros pavaros - 5 taškų spyna skląstys ir apsauginiai kaiščiai užsirakina automatiškai uždarius duris. Pagrindinis užraktas rakinamas tik raktu. Visi kaiščiai atrakinami tik raktu.

L5PA electric - 5 taškų spyna visos skląstys ir apsauginiai kaiščiai valdomi elektrine pavara. Užsirakina automatiškai, kai durys uždaromos. Skląstys ir pagrindinė spyna atrakinami elektrine pavara kai pasukamas raktas arba nulenkiama rankena. Nesuderinama su nulenkiama rankena iš lauko. Spyna gali būti sujungta su pirštų antspaudų skaitytuvu arba kodiniu valdikliu (papildomai)

L5P + panic function electric - 5 taškų spyna. Skląstis ir apsauginiai kaiščiai užsirakina automatiškai uždarius duris. Pagrindinis užraktas rakinamas raktu. Skląstis ir pagrindinė spyna atrakinami kai nulenkiama vidinė rankena.



L3P



L5P

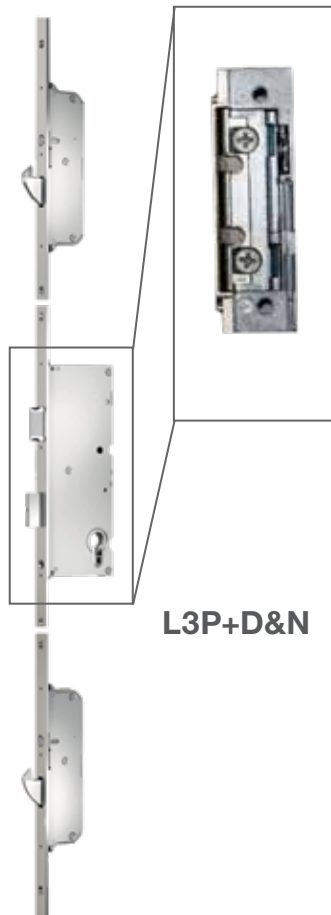

L3P+D&N



L3P+D&N+EM

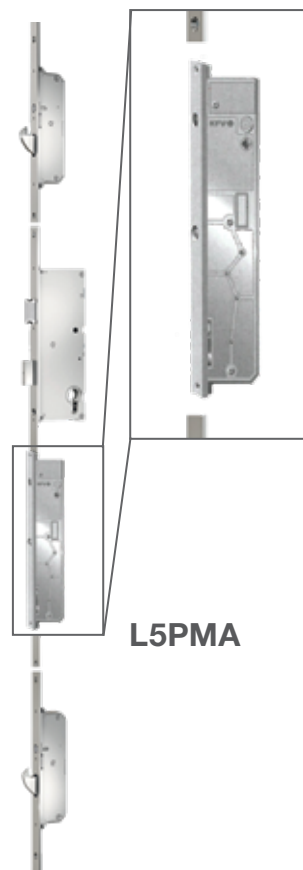

L5PMA



L5PM

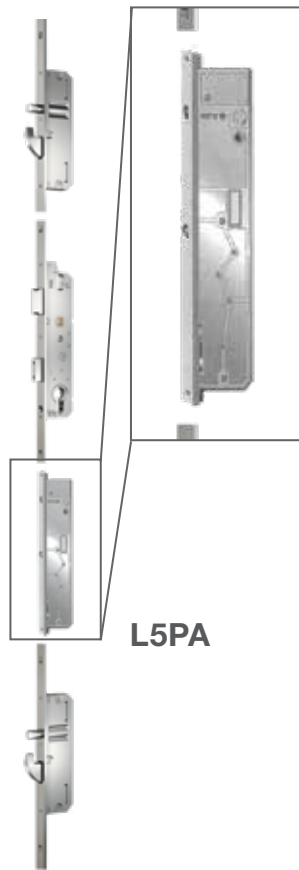

L5PA



**L5P+
panic
funkcija**



200



201



202



203



204



205



206



207



208



301



302



303



304



305



306

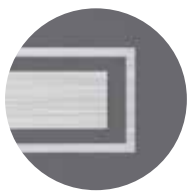

“Šukuotas” nerūdijantis plienas

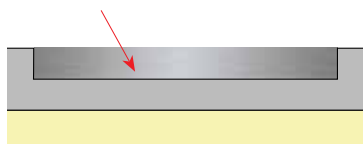

Įleista nerūdijančio plieno aplikacija aplikacija

Raižiniai



307



308



309



310



311



312



313



314



315



316



317



401

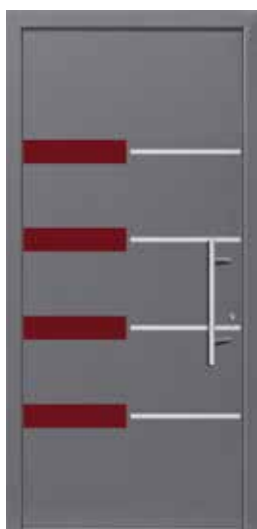

402



501



502



503



504



505



506



507



508



509



510



511



512



601



602



603



604



605



606



607



608



609



610



611



612



613



614



615



616



617



618



619



620



621



622



623



624



625



626



627



628



629



630



631



632



633



634



635



636



637



638



639



640



641



642



643



644



645



646



647



648



649



650



651



652



653



654



655



656



657



701



702



703



704



705



706

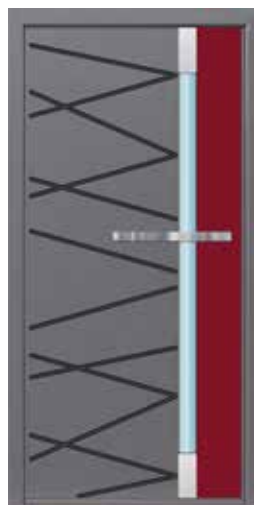

801



802



803



804



805



901



902

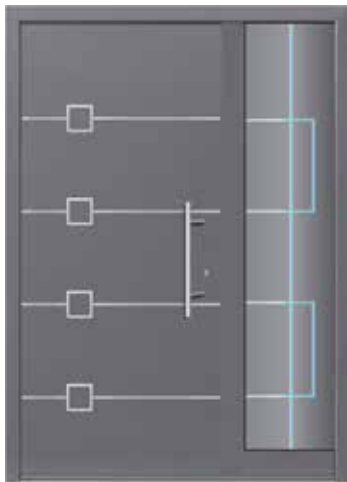

903

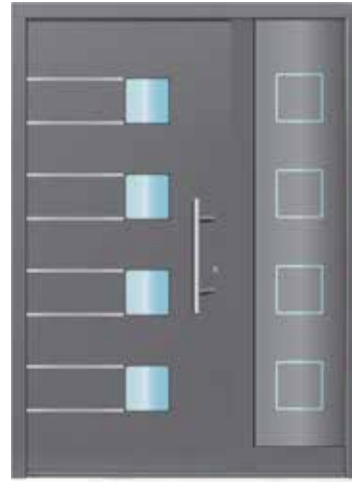

904



905

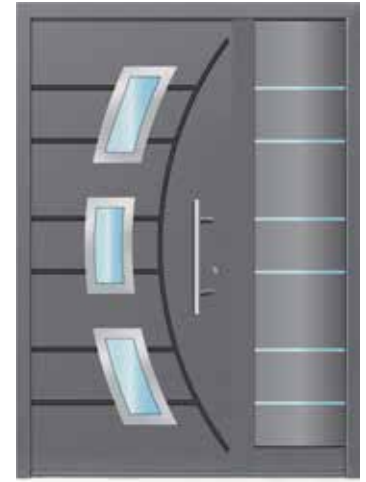

906

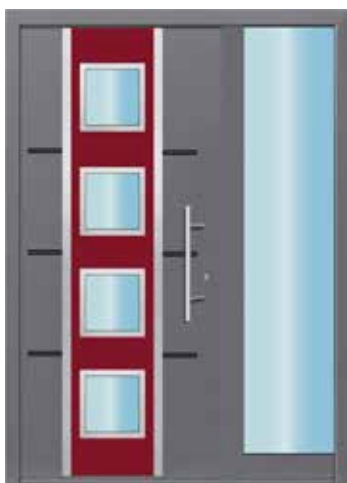

907

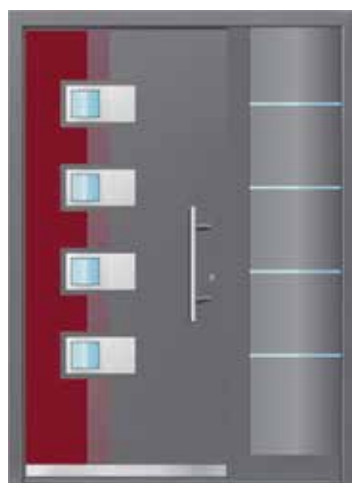

908

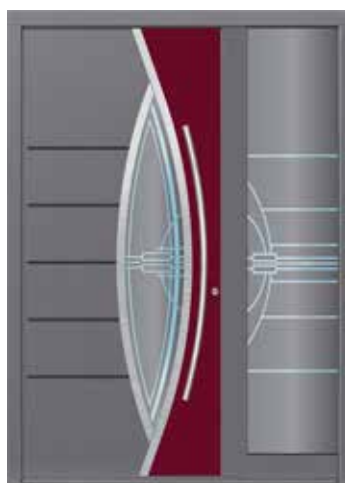

909

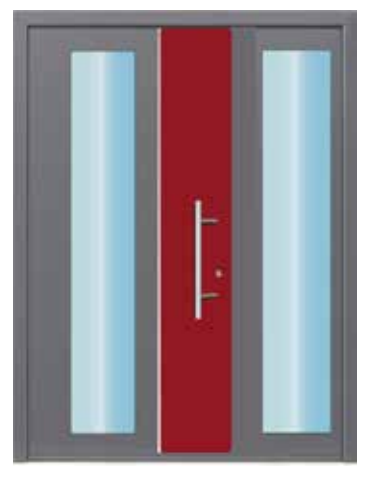

910



1000 Betono plokštė



1001 Betono plokštė



1002 Betono plokštė



1003 Betono plokštė



1004 Betono plokštė



1005 Betono plokštė



1006 Betono plokštė



1007 Betono plokštė



1008 Betono plokštė



1009 Betono plokštė

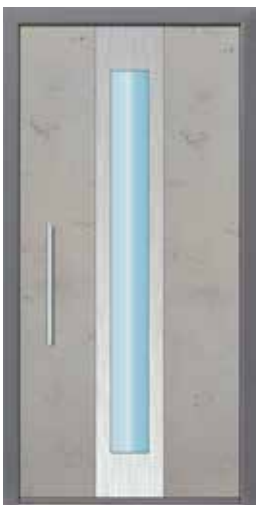

1010 Betono plokštė



1011 Betono plokštė

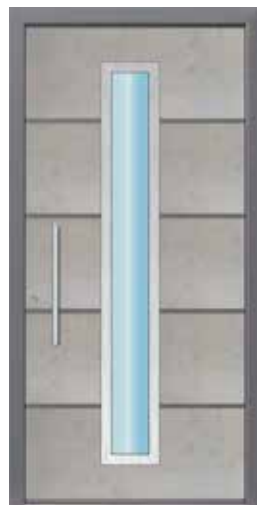

1012 Betono plokštė



1020 corten



1021 corten



1022 corten



1023 corten



1024 corten



1025 corten



1026 corten



1027 corten



1028 corten

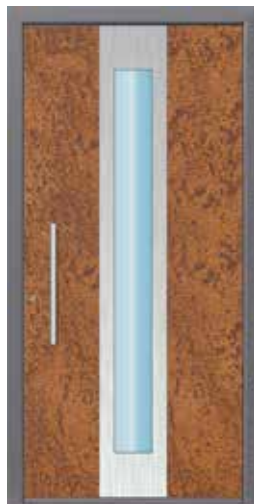

1029 corten



1030 corten

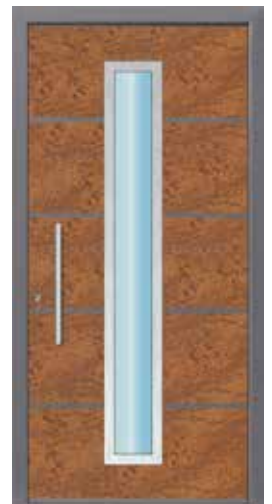

1031 corten



1032 corten



1040 medis



1041 medis



1042 medis



1043 medis



1044 medis



1045 medis



1046 medis



1050 stiklas



1051 stiklas



1052 stiklas



1053 stiklas



1054 stiklas



1055 stiklas+corten



Individualus modelis



<https://ryternaentry.doorconfigurator.com/>

release date:
27.06.2022



www.ryterna.lt
<https://ryternaentry.doorconfigurator.com>